

Wentylator N24, 3- fazowy



Wentylator N24, 3-fazowy



- ✓ Kompaktowy
- ✓ Proste użytkowanie

Wentylator promieniowy przeznaczony głównie do użytku z produktami odciągowymi firmy Nederman













Wentylator N24, 3-fazowy

Certyfikaty	CE
Poziom hałasu (dB(A))	61 dB przy 1200 m ³ /h
Instalacja	wewnątrz, na zewnątrz
Materiał	Obudowa wentylatorów: blacha ocynkowana Wirnik: odlew aluminium
Przepływ powietrza (m ³ /h)	1500
Pojemność (maks. przepływ powietrza m ³ /h)	1750
Temperatura otoczenia	-20 to +40 C (-4 F to 104 F)
Częstotliwość (Hz)	50
Liczba faz	3
Waga (kg)	17
Moc (kW)	0,9









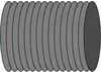
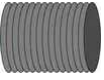

Models

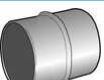
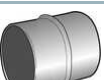
	Item number	Napięcie zasilania (V)	Natężenie prądu (A)
	14510422	220-240/380-420	3,10/1,80
	14511522	200	3,8
	14513522	200	3,8







Accessories

	Accessory	Item number
	Fan Control Man 3~ 1-5A	14518637
	Fan Control Autom 3~ 1-5A	14519037
	Redukcja 4"-5" 125/100mm	14341077
	Redukcja 125/75	14341080
	Reducer Ø160-75	14510426
	Reducer Ø160-100	14510526
	Reducer Ø160-125	14510626
	Reducer Ø160-150	14511226
	Adaptor śred. 160 mm	14510326
	Wlot i wylot do wentylatora	14322166
	Siatka zabezpieczająca do N16 i N24	14333181
	Wąż PCV 4" L= 5m	10500427
	Wąż Ø5" L=5m PVC	10500527

Accessories

	Accessory	Item number
	Wąż Ø6" L=5m PVC	10500627
	Wąż odciągowy PVC śr. 160mm, 5m	10511026
	Złączka 3"-3". (75mm).	14503626
	Złączka 4"-4". (100mm).	14504626
	Złączka 5"-5". (125mm).	14505626
	Złączka 6"-6". (150mm).	14506626
	Adapter Ø160mm	14511326
	Ssawka z magnesem	14500226
	Ssawka magnet. tworzywo	14501226
	Tłumik do wentylatora	14502126
	Tłumik do wentylatora	14502626
	Tłumik hałasu do wentylatora	14502226
	Wspornik ścienny do tłumika, para	14343089

Accessories

	Accessory	Item number
	Trójnik 125 /2 x 125	14500726
	Trójnik 2x 1600 x 100	14510726
	Trójnik Ø125mm/2x75mm.	14500826
	Wspornik do N10/N16/N24 do montażu stałego. Z siatką ochronną i podłączeniem wlotu.	14510126
	Stojak do wentylatora N16, N24	14511426
	Załącznik do wentylatora	14502237

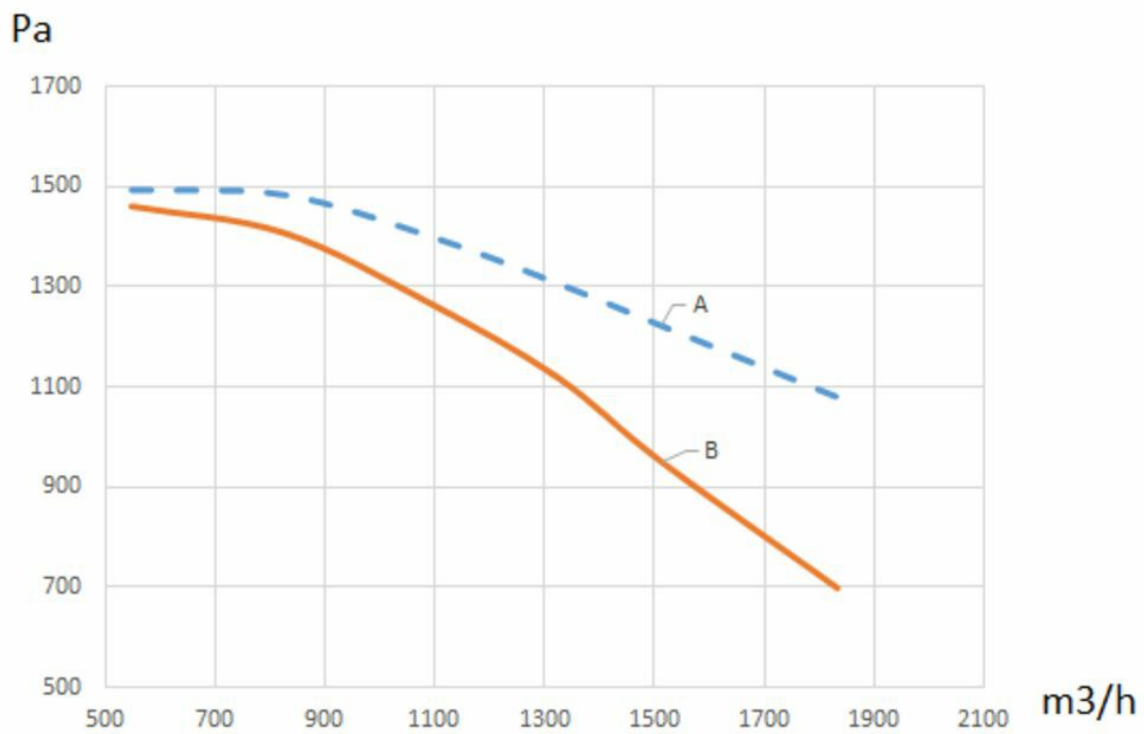
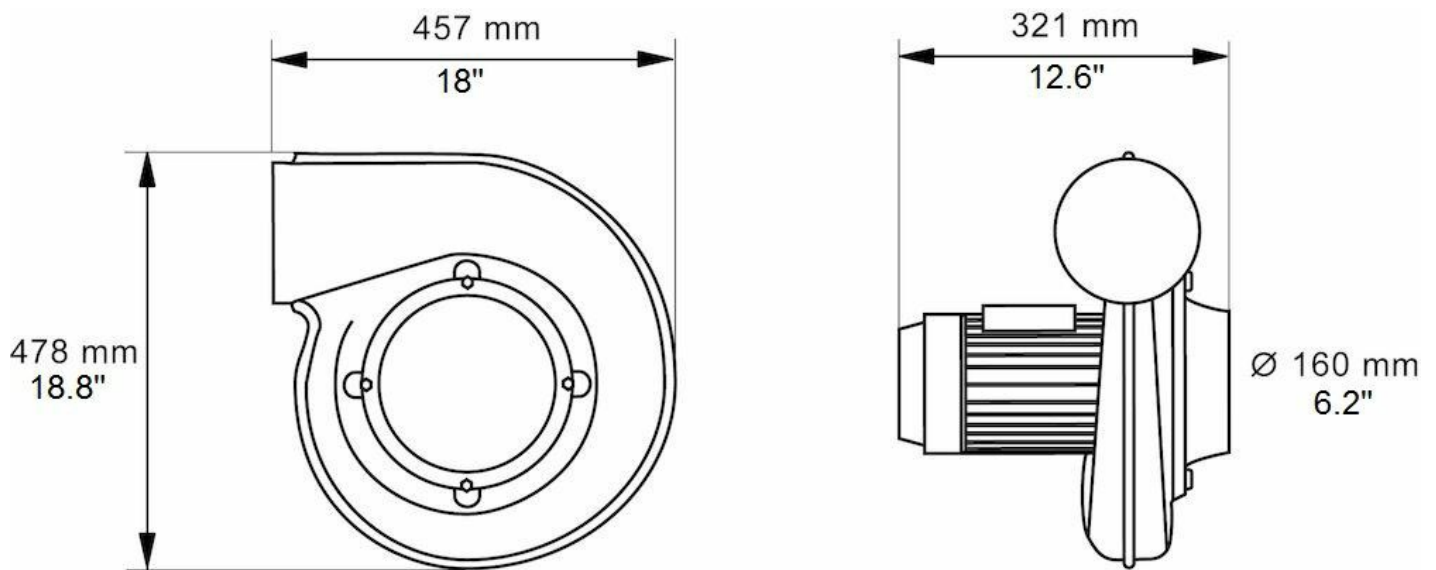

A = Fan total pressure B = Fan static pressure